

## Z2000 SPECIFICATION

CHARACTERISTICS			Tailift	Tailift	Tailift	Tailift	Tailift	Tailift	Tailift	Tailift	Tailift	Tailift
1	Manufacturer		Tailift	Tailift	Tailift	Tailift	Tailift	Tailift	Tailift	Tailift	Tailift	Tailift
2	Series		Z2000	Z2000	Z2000	Z2000	Z2000	Z2000	Z2000	Z2000	Z2000	Z2000
3	Model		ZFBT18	ZFBT20	ZFB15	ZFB18	ZFB20	ZFB25	ZFB25	ZFB30	ZFB35	ZFB35
4	Capacity	Q Load	3500	4000	3000	3500	4000	5000	5000	6000	7000	7000
5	Load center	C Distance	24	24	24	24	24	24	24	24	24	24
6	System		AC	AC	AC	AC	AC	AC	AC	AC	AC	AC
7	Power type	Electric, Diesel, Gasoline, LPG	Electric	Electric	Electric	Electric	Electric	Electric	Electric	Electric	Electric	Electric
8	Operation type	Pedestrian, Stand, Sit	Sit	Sit	Sit	Sit	Sit	Sit	Sit	Sit	Sit	Sit
9	Lift at 2-stage mast	h3 Lift (maxi. Fork height)	118.1	118.1	118.1	118.1	118.1	118.1	118.1	118.1	118.1	118.1
10		h2 Standard free lift	5.5	5.5	5.5	5.5	5.7	5.7	5.7	5.9	5.9	5.9
11	Mast tilting angle	Forward (α) / Back (β)	6/6	6/6	6/12	6/12	6/10	6/10	6/10	6/10	6/10	6/10
12		L2 Length to face of forks	79.9	79.9	80.5	80.5	90.2	90.2	90.2	95.2	95.2	95.2
13		B Total width	42.9	42.9	42.5	42.5	47.2	47.2	47.2	49.6	49.6	49.6
14	Overall Dimensions	h6 Overhead guard height	82.3	82.3	84.4	84.4	84.5	84.5	84.5	84.5	84.5	84.5
15		h1 Mast height lowered	78.3	78.3	78.3	78.3	81.7	81.7	81.7	81.7	81.7	81.7
16		h4 Mast height extended	166.1	166.1	169.1	169.1	169.1	169.1	169.1	169.1	169.1	169.1
17		h7 Seat Height	39.2	39.2	44.5	44.5	45.1	45.1	45.1	45.1	45.1	45.1
18	Turning radius	R	62.6	62.6	72.4	72.4	79.9	79.9	79.9	84.3	84.3	84.3
19	Tire type	S=Solid, P=Pneumatic	front/rear	Solid	Solid	Pneumatic	Pneumatic	Pneumatic	Pneumatic	Pneumatic	Pneumatic	Pneumatic
20	Wheels (X:driven)	Number	front/rear	2x/2	2x/2	2x/2	2x/2	2X/2	2X/2	2X/2	2X/2	2X/2
21		front		18x7-8	18x7-8	21x8x9-14PR	21x8x9-14PR	23x9-10-16PR	23x9-10-16PR	23x9-10-20PR	23x9-10-20PR	23x9-10-20PR
22	Tire size	rear		15x4 1/2-8	15x4 1/2-8	5-8-8P.R.	5-8-8P.R.	18x7-8	18x7-8	18x7-8	18x7-8	18x7-8
23		Battery Voltage	V	48	48	48	48	48	48	80	80	80
24	Battery	min. capacity	AH/SHR	505	505	460	460	560	560	560	560	560
25		max. capacity	AH/SHR	660	660	600	600	700	700	600	600	600
26		Battery box size LxWxH	in	37.9x24.0x24.4	37.9x24.0x24.4	38.4x18.3x29.5	38.4x18.3x29.5	44.3x24.0x29.9	44.3x24.0x29.9	44.3x24.0x29.9	44.3x24.0x29.9	44.3x24.0x29.9
27	Motor	Drive motor	kw	4.2x2	4.2x2	7	7	7	7	12	12	12
28		Pump motor	kw	12	12	12	12	12	12	16	16	16

★ This is only for your reference and not subject to notice in advance if there is any modification.

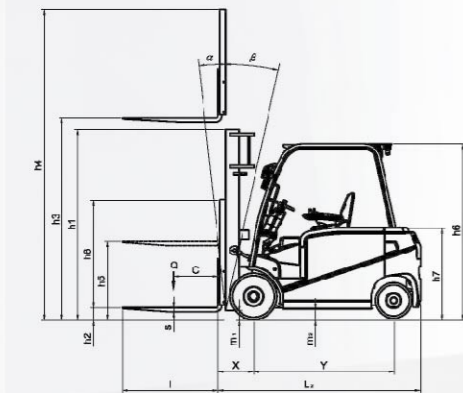

www.tailift.com

### Tailift MAIN OFFICE:

No.5,Zili 1st Rd.,Nantou City,Nantou 540,Taiwan (R.O.C.)  
 TEL: 886-49-2263800 FAX: 886-49-2258979  
 Website: http://www.tailift.com  
 E-mail: insales@tailift.com.tw

### Tailift USA CO.,INC

11778 San Marino Street, Rancho Cucamonga, CA 91730  
 TEL: 909-930-9801 (2) FAX: 909-930-9739  
 DOC.S/N: DEB054 Edition:01



# Tailift

## Z-2000 ELECTRIC FORKLIFT TRUCKS

# New Generation

## SERIES 3000-7000 lb



www.tailift.com

## Optimal Performance & Ultimate Productivity

### Advanced AC controller system

- All models come standard with total AC controller. Low maintenance and low noise for AC traction and hydraulic motors
- Remarkable speed control and clever torque control protection against battery polarity
- Regenerative braking
- Electrically assisted braking
- Over temperature protection for inverters and motors
- Full protection against short or open circuits
- Drive speed acceleration / deceleration
- Anti-roll back with adjustable ramp stop time



The zapi's anti-rollback system provides a safe ramp operation and an exceptional ramp start capability. The powerful high-output motors provide greater acceleration, better grade-ability and faster travel speed on any tough terrain or slope.

### Hydraulic pump motor

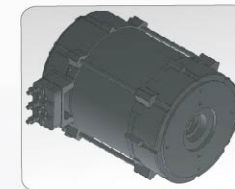

- AC hydraulic pump motor can be adjusted to low speed of output, provide sufficient power for turning and long operating life.
- The truck's power saving functions enhances the truck's ability to operate for longer periods without reducing productivity or performance.

### Wet Disc Brakes(ZF)



- ZF wet disc brake is standard on all Z2000 series models to assure dependable and reliable braking performance
- Wet disc brakes with multiple discs require less maintenance and reduce service cost.

### Reliable Transmission



- Using ZF transmission
- Low noise
- High safety
- Low maintenance cost over the life of the truck
- High reliability, good durability

### Brake Improvement

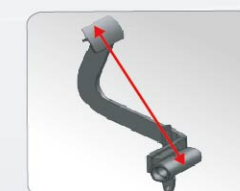

- **1.25times** longer brake pedal arm
- Braking force is **2 times** more. Braking distance improve from 13' (7L) to 6.5' (Z2000)
- Enlarged brake pump to increase oil level
- Optional brake oil level alarm

### Front dual drive motor reduced small turning radius (standard for FBT)

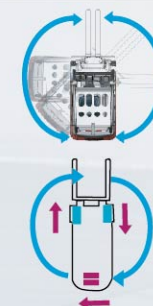

- Front dual drive motor individual motor control left and right wheels
- Front and rear wheels will automatically reverse in different way to reduce turning radius( FBT model)

### Steering Angle Sensor & Controls

	Series	7L	Z2000
1	Turning Speed Limit	x	v
2	Water Proof & Dust Proof	x	IP67
3	Accuracy	5%	1%
4	Long Mechanical Life cycles	10million cycles	50million cycles
5	Robust Operating Temperature	-20°C to 70°C	-40°C to 125°C

## ELECTRIC FORKLIFT TRUCKS

# The Best Solution For Your Application

Tailift's new electric counterbalanced forklifts bring bold improvement to the market with significant reductions in total operating costs, while improving truck performance and productivity. Tailift's Z-2000 series four-wheel and three-wheel electric forklifts feature new and innovative engineering ideas to show Tailift's commitment to fulfilling customer needs, conserving our environment, and reducing costs of ownership.

## Intelligent Ergonomics and Superior Comfort

An ergonomically designed operator's compartment enables the driver to select the most comfortable working position to increase productivity

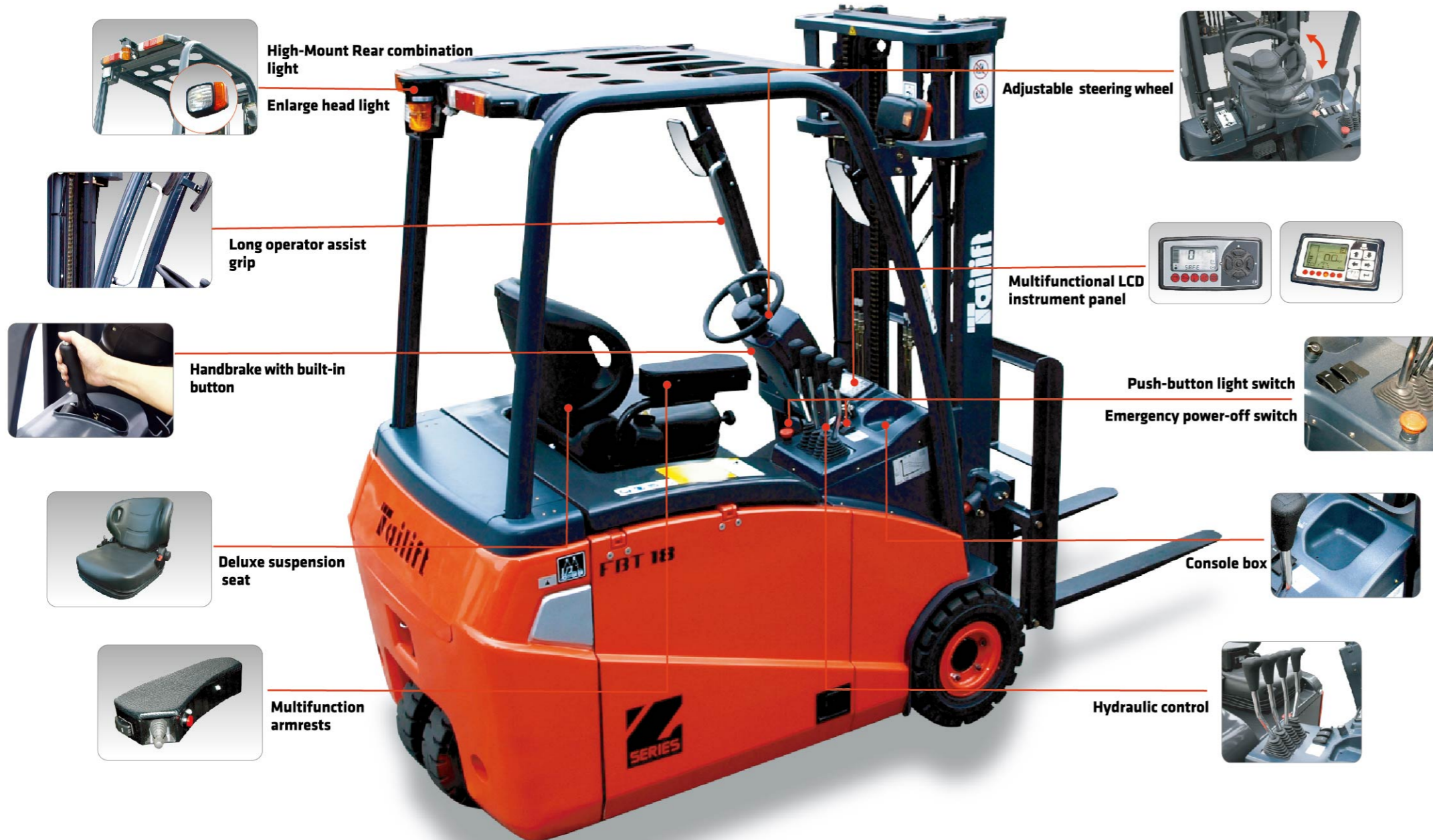

### • Multifunctional LCD instrument panel

A large and easy-to-read multifunctional LCD panel is ergonomic designed for the operator. It is designed 40 degrees on the right hand angle of the operator and help operator to read.

### • Superior comfort cabin

The new Z series is focusing on working environment and operator's comfort. The new cabin is designed with no blind spot. It is a comfortable and safe work place for the operator. The Cabin's 360 degrees crystal view minimizes the risk of damage to operator and goods. Wide range of optional equipments such as heater and radio in the interior lining of the overhead guard to meet all your needs.

### • Hydraulic control

The ergonomic design of levers provides the perfect positions for operator's hand without causing any extra stress. Multifunction armrests with F/R control lever make forward and reverse easier. Speakers at the lower left and use of the thumb can easily manage.



Enlarge Non-slip mat



Enlarge operation space



Electric minilever and joystick

### Enlarged operation space

- Ergonomic designed and easy for everyone to operate
- Wide -open foot space provides comfortable foot activity space
- The enlarged space give operator great comfortable and less stress
- Increase productivity

### Electric minilever and joystick

Optional advanced hydraulics minilever and joystick with armrest are all new design gives more comfort to the operator.

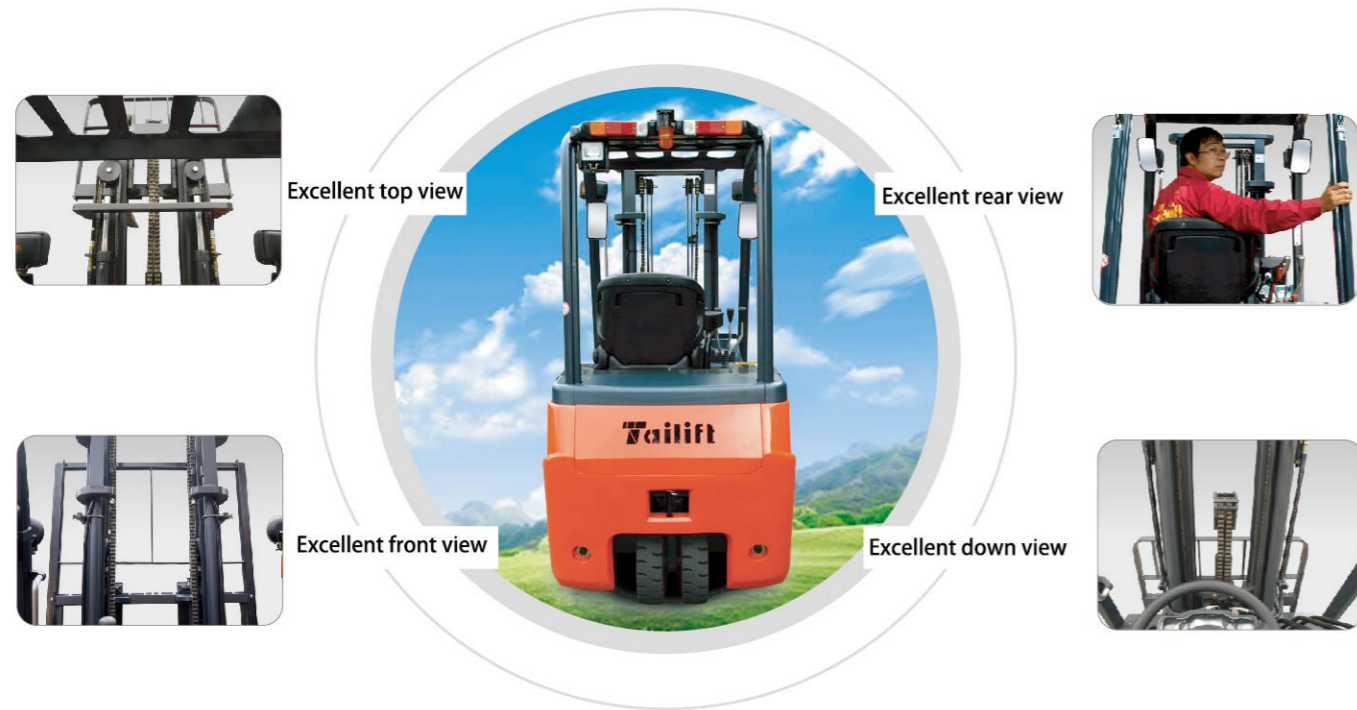

**Clear view for operator**

Low profile front cowl with sloped dashboard provide an unobstructed view in any position. The Z series clear view mast standard with 5.5 inch free lift, back type roller and hiding hose and the new fork carriage assembly allow for excellent visibility and higher residual load capacity.

**Low cost of ownership**



- **Side battery access**  
Side battery access is easy to remove or exchange the truck battery
- **High performance**  
Long operation hours 6-8 hours

• **Battery cover easy to open**



• **Rear service panel**  
Rear service panel are easy remove for quick service check and repair

• **Centralized fuse box**  
A centralized fuse box for easy inspection



**Braking system**

Simplify mechanical linkage of vertical braking system to reduce drive component wear and tear. Extend brake pedal and mechanical working life.



• **Multi-piece footpetal**

Multi-piece footpetal make maintenance more convenient and fast

**Electric Power Steering System (EPS) Optional**

Allows accurate positioning of the steering wheel , improving operator comfort and safety



**Hydraulic steering axle**

- The new axle provides wider steering angles to 85 degrees and reduces to a smaller turning radius
- Compact size allows the truck to work in narrower aisles
- Grease nipples located on the contact points will save time and cost to do maintenance

**Smaller steering wheel**

- Smaller steering wheel is easy to operate and reduce operator's arm and shoulder's workload. New steering wheel's diameter reduces from 13" to 11".
- The easy-handling steering wheel column with tilt adjustment helps to provide the ideal operating position and improve performance.

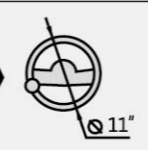
	7L	Z2000
Diameter		
Turning Force	2.2lbs	1.1lbs

**Safety & Gold service**

The complete electrics are protected against water and dust according to IP54.



**Integral heavy duty chassis**

A strong no-bolt integral heavy duty chassis gives the driver 20% more protection from falling loads. Tailift forklifts built with Integral heavy duty chassis, suitable for all kind working surface.



**Hydraulic lock out system**

Our new hydraulic lock out system option which automatically lock off all hydraulic functions and transmission drive if it has not detected the presence of the operator. ( STD when you choose electric minilever )